

YERKURE

Mining Equipment

As Yerküre Mining Equipment, we are a power groups in the mining industry, defined by trust, quality and durability. With 6 years of experience, we offer equipment built with high durability to facilitate the ongoing challenge deep in the mine. Our products combine reliability and performance, enabling safe, uninterrupted and efficient operation in the field.

We aim to provide not only the best for our customers, but also solutions that fit their budget. In this way, we stand as a solid business partner to the industry that works steadfastly in the depths of the mine.

With Yerküre Mining Equipment, let's take strong steps together for a safe and quality future.

Bring the power of underground together with the assurance of Yerküre.

YERKÜRE

Mining



CORE DRILLING EQUIPMENT

YERKURE
Mining

IN HOLE TOOLS / KUYU İÇİ EKİPMANLAR CORE BARREL KITS / KAROTİYER KİTLERİ

PWL / HWL / NWL / BWL CORE BARREL KIT PWL / HWL / NWL / BWL KAROTİYER KİTİ

#	DESCRIPTION / TANIMLAMA
1A	INNER TUBE HEAD ASSY.
2	INNER TUBE 05 FT INNER TUBE 10FT
3	STOP RING
4	CORE LIFTER FLUTED
5	CORE LIFTER CASE
6	TCW LOCKING COUPLING-T
7	ADAPTER COUPLING
8	LANDING RING
9	OUTER TUBE 05 FT OUTER TUBE 10 FT
10	INNER TUBE STABILIZER

#	DESCRIPTION / TANIMLAMA
1B	NWLU INNER TUBE HEAD ASSY.
2	INNER TUBE 05 FT INNER TUBE 10FT
3	STOP RING
4	CORE LIFTER FLUTED
5	CORE LIFTER CASE
6	TCW LOCKING COUPLING-T
7	ADAPTER COUPLING
8	LANDING RING
9	OUTER TUBE 05 FT OUTER TUBE 10 FT
10	INNER TUBE STABILIZER

#	DESCRIPTION / TANIMLAMA
1	NWL3 INNER TUBE ADAPTER
2	PISTON BOLT
3	WL-RING, 3.00X41.00
4	NWL3 PISTON
5	NWL3 SPLIT TUBE 05 FT NWL3 SPLIT TUBE 10 FT
6	NWL3 STOP RING
7	NWL3 CORE LIFTER FLUTED
8	NWL3 CORE LIFTER CASE

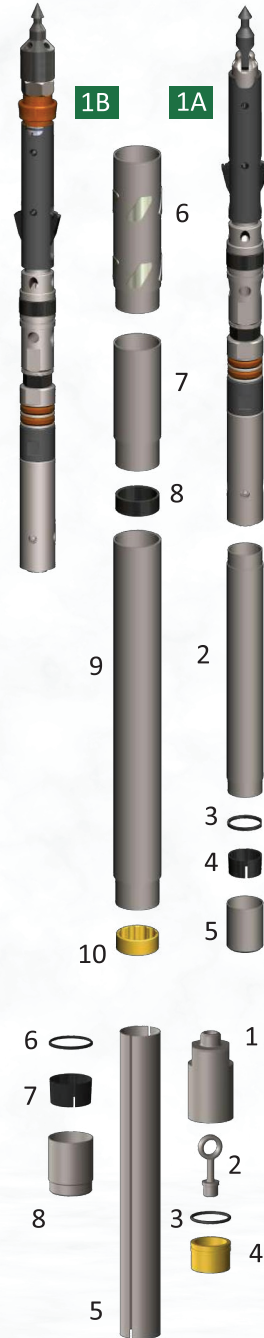

IN HOLE TOOLS / KUYU İÇİ EKİPMANLAR HEAD ASSEMBLY / KAROTİYER BAŞLIĞI

PWL / HWL / NWL / BWL HEAD ASSEMBLY ITEMS PWL / HWL / NWL / BWL BAŞ MONTAJ ÜRÜNLERİ

#	DESCRIPTION / TANIMLAMA
1	SPEARHEAD
2	STEEL BALL, 9.5 MM
3	SPEARHEAD SPRING
4	SPEARHEAD BASE
5	SPIROL PIN, 12X30
6	LATCH CASE
7	SPRING PIN, 12X55
8	IMBUS BOLT, M10
9	SPRING WASHER
10	LATCH SPRING
11	UPPER LATCH BODY
12	LATCH
13	LINK
14	SPRING PIN, 12X70
15	STEEL BALL, 22.2 MM
16	BUSHING
17	LANDING SHOULDER
18	LOWER LATCH BODY
19	NORD LOCK WASHER, M22
20	HEX. NUT 1-1/4"
21	SPINDLE
22	SHUT OFF VALVE
23	INNER TUBE WASHER
24	BEARING, 51306
25	BEARING BUSHING
26	COMPRESSION SPRING
27	BEARING, 51205
28	LOCK NUT 1"
29	INNER TUBE CAP
30	NWL CHECK VALVE BODY
31	GREASE FITTING, M6

#	DESCRIPTION / TANIMLAMA
1	SPEARHEAD
2	HEX. NUT 1-1/2"
3	PUMP SEAL
4	SEAL WASHER
5	SPEARHEAD BASE
6	WL RING, 2.62X52.00

- STANDART HEAD ASSEMBLY PARTS
- CONVERTING HEAD ASSEMBLY PARTS



IN HOLE TOOLS / KUYU İÇİ EKİPMANLAR OVERSHOT

BWL / NWL / HWL / PWL OVERSHOT

#	DESCRIPTION / TANIMLAMA
1	OVERSHOT CABLE SWIVEL ASSY.
2	GRASE FITTING, M6
3	NWL OVERSHOT UPPER BODY
4	NWL OVERSHOT JAR STAFF
5	NWL OVERSHOT LOWER BODY
6	HEX. NUT, M18
7	NORD LOCK WASHER, M20
8	NWL OVERSHOT SPRING WASHER
9	NWL OVERSHOT BUSHINGSRING
10	NWL OVERSHOT SLEEVE
11	STEEL BALL, 9.5 MM
12	OVERSHOT LOCK SPRING
13	HWL OVERSHOT HEAD
14	OVERSHOT LIFTING DOG
15	OVERSHOT HEAD SPRING
16	SPRING PIN, 12X55
17	SPRING PIN, 06X55
18	NWL OVERSHOT SLEEVE

#	DESCRIPTION / TANIMLAMA
1	OVERSHOT CABLE SWIVEL ASSY.
2	GRASE FITTING, M6
3	NWL OVERSHOT UPPER BODY
4	NWL OVERSHOT JAR STAFF
5	NWL OVERSHOT LOWER BODY
6	HEX. NUT, M18
7	NORD LOCK WASHER, M20
8	NWL OVERSHOT SPRING WASHER
9	NWL OVERSHOT BUSHINGSRING
10	NWL OVERSHOT SLEEVE
11	STEEL BALL, 9.5 MM
12	OVERSHOT LOCK SPRING
13	NWL OVERSHOT HEAD
14	OVERSHOT LIFTING DOG
15	OVERSHOT HEAD SPRING
16	SPRING PIN, 12X80
17	SPRING PIN, 06X50
18	NWL OVERSHOT SLEEVE
19	PWL OVERSHOT STABILIZER

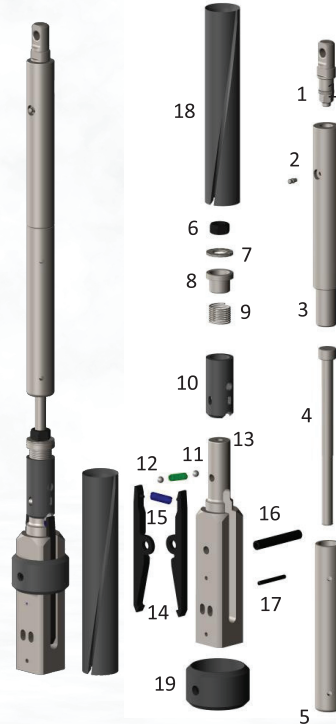
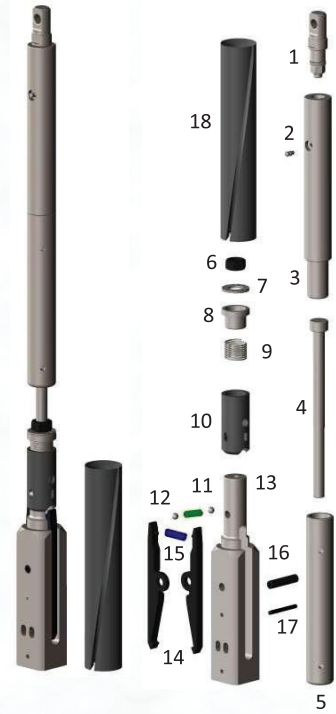

OVERSHOT ASSEMBLIES

UNDERGROUND OVERSHOT

DESCRIPTION / TANIMLAMA

1	OVERSHOT CABLE SWIVEL ASSY.
2	GRASE FITTING, M6
3	BWLU OVERSHOT UPPER BODY
4	BWLU PUMP SEAL
5	BWLU OVERSHOT SPINDLE, SEAL
6	STEEL BALL, 22.2 MM
7	BUSHING
8	BWLU OVERSHOT HEAD
9	BWL OVERSHOT LIFTING DOG
10	OVERSHOT HEAD SPRING
11	SPRING PIN, 12X40
12	SPRING PIN, 06X40

DESCRIPTION / TANIMLAMA

1	OVERSHOT CABLE SWIVEL ASSY.
2	GRASE FITTING, M6
3	NWLU OVERSHOT UPPER BODY
4	NWLU PUMP SEAL
5	NWLU OVERSHOT SPINDLE, SEAL
6	STEEL BALL, 22.2 MM
7	BUSHING
8	NWLU OVERSHOT HEAD
9	NWL OVERSHOT LIFTING DOG
10	OVERSHOT HEAD SPRING
11	SPRING PIN, 12X50
12	SPRING PIN, 06X50

DESCRIPTION / TANIMLAMA

1	OVERSHOT CABLE SWIVEL ASSY.
2	GRASE FITTING, M6
3	HWLU OVERSHOT UPPER BODY
4	HWLU PUMP SEAL
5	HWLU OVERSHOT SPINDLE, SEAL
6	STEEL BALL, 22.2 MM
7	BUSHING
8	HWLU OVERSHOT HEAD
9	HWL OVERSHOT LIFTING DOG
10	OVERSHOT HEAD SPRING
11	SPRING PIN, 12X55
12	SPRING PIN, 06X55

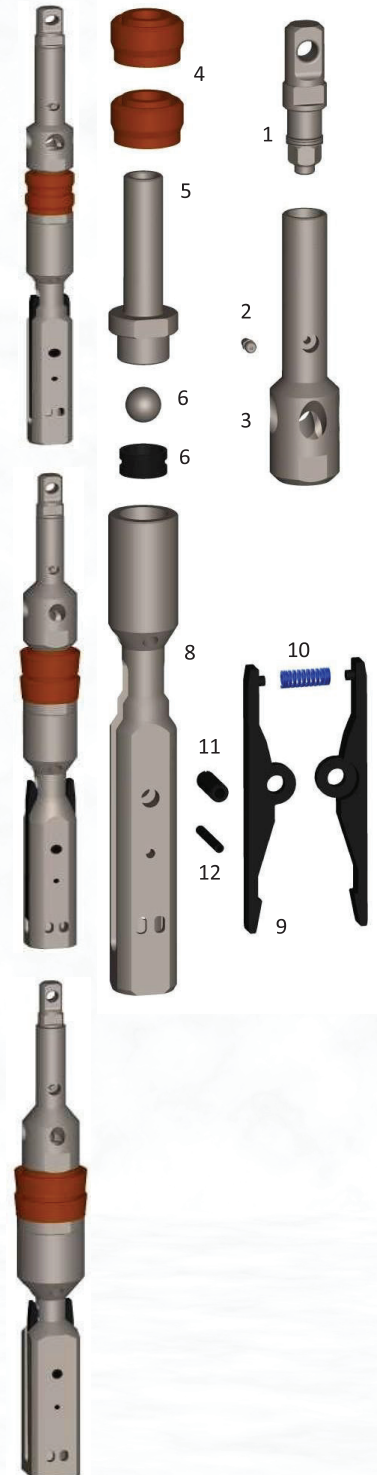

ACCESSORIES

LOCKING COUPLINGS

DESCRIPTION / TANIMLAMA

1	BWL/BWLU TCW LOCKING COUPLING, TANGED
2	BWL/BWLU TCW LOCKING COUPLING
3	NWL/NWL3/NWLU TCW LOCKING COUPLING, TANGED
4	NWL/NWLU TCW LOCKING COUPLING
5	HWL/HWL3/HWLU TCW LOCKING COUPLING, TANGED
6	HWL/HWL3/HWLU TCW LOCKING COUPLING
7	PWL/PWL3/PWLU TCW LOCKING COUPLING, TANGED
8	PWL TCW LOCKING COUPLING

DESCRIPTION / TANIMLAMA

1	BWL/BWLU FHL LOCKING COUPLING, TANGED
2	BWL/BWLU FHL LOCKING COUPLING
3	NWL/NWL3/NWLU FHL LOCKING COUPLING, TANGED
4	NWL/NWLU FHL LOCKING COUPLING
5	HWL/HWL3/HWLU FHL LOCKING COUPLING, TANGED
6	HWL/HWL3/HWLU FHL LOCKING COUPLING
7	PWL/PWL3/PWLU FHL LOCKING COUPLING, TANGED
8	PWL FHL LOCKING COUPLING

DESCRIPTION / TANIMLAMA

1	BWL TCI LOCKING COUPLING, TANGED
2	BWL/BWLU TCI LOCKING COUPLING
3	NWL/NWL3/NWLU TCI LOCKING COUPLING, TANGED
4	NWL/NWLU TCI LOCKING COUPLING
5	HWL/HWL3/HWLU TCI LOCKING COUPLING, TANGED
6	HWL/HWL3/HWLU TCI LOCKING COUPLING
7	PWL/PWL3/PWLU TCI LOCKING COUPLING, TANGED
8	PWL TCI LOCKING COUPLING

DESCRIPTION / TANIMLAMA

1	BWL IMP LOCKING COUPLING, TANGED
2	BWL/BWLU IMP LOCKING COUPLING
3	NWL/NWL3/NWLU IMP LOCKING COUPLING, TANGED
4	NWL/NWLU IMP LOCKING COUPLING
5	HWL/HWL3/HWLU IMP LOCKING COUPLING, TANGED
6	HWL/HWL3/HWLU IMP LOCKING COUPLING
7	PWL/PWL3/PWLU IMP LOCKING COUPLING, TANGED
8	PWL IMP LOCKING COUPLING

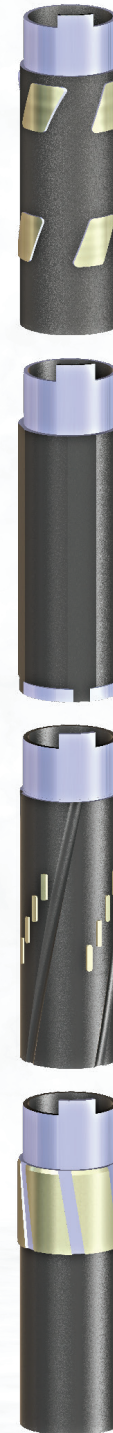

IN HOLE TOOLS

OTHER TOOLS

Water Swivels

- Light Type Water Head
- Heavy Type Water Head
- Underground Water Head

Water heads are offered in various configurations to meet different operational requirements, including underground and surface drilling. Designed according to drilling depth and application conditions, these heads provide reliable water flow and contribute to efficient drilling processes.



Hoist Plugs

- Standard Maneuver Head
- Heavy Duty Maneuver Head

Maneuver heads are available in two types: Standard and Heavy Duty. The Standard Maneuver Head is recommended for shallow drilling operations, while the Heavy Duty Maneuver Head is an ideal choice for deeper drilling operations.



Compact Duty Water Swivel



Underground Pumping Swivel



Inner Recovery Tap, Right Hand



Adapters



IN HOLE TOOLS

OTHER TOOLS



Core Lifters



Road Cutter



Rod Reaming Shell



Diomand Crown C/S
Diomand Crown Rod Shoe
Carbite Casing Shoe



Coring PCD Bits
Non-Coring PCD Bits



Rods and Casing



DRILL RIGS

YERKURE
Mining

YKM-2000 DIAMOND CORE DRILLING RIG TECHNICAL SPECS

Drilling Depth Capacity	
Drill Rod	Drilling Depth, meters <i>Based on fluid filled hole conditions</i>
BQ	3462
NQ - V wall	2983
NQ	2661
HQ - V wall	2246
HQ	1806
PQ - V wall	1592
PQ	1190

Engine (Prime Mover)	
Engine (Prime Mover)	Cummins 6LTAA8.9-C360, 6 cylinder, turbo charged, inter cooled diesel engine.
Displacement	8.9 L
Power (maximum) at 2,100 RPM	360 hp

PQ Drill Head - Hollow Spindle		
Maximum Rod Diameter	127 mm	
Rotation Motor	Rexroth A6VM160 hydraulic motor - variable/reversible	
Mechanical Transmission Ratios	Funk 4 speed	
	1st	6.27:1
	2nd	3.12:1
	3rd	1.75:1
	4th	1.00:1
Final Drive Ratio	Straight Cut Gears 2:1	
Head Opener	Sliding style — Hydraulic operation	
Hydraulic PQ Chuck	Chuck-Hydraulically opened, nitrogen or steel spring closed. Axial holding capacity of 222 000 N	
Drill Head Lubrication	Force fed bearings, - hydraulically driven oiling pump and cooling and circulation system	
Drill Head Lubrication Oil Filtration	25 Micron high pressure oil filter	

Torque And RPM Ratings - PQ Head		
(Hydraulic motor at maximum/minimum displacement, prime mover at 2,200 RPM)		
	Speed (no load) RPM	Torque (stall) Nm
1st Gear	144- 199	5322 - 3826
2nd Gear	288 - 400	2648 - 1898
3rd Gear	514 - 714	1486 - 1068
4th Gear	900 - 1,250	849 - 610

YKM-2000 DIAMOND CORE DRILLING RIG TECHNICAL SPECS

Hydraulic System	
Primary Pump	Kawasaki K3VL140 cc Axial piston, variable displacement load sensing, pressure compensated with low pressure standby.
Max Flow	280 L/m
Maximum Pressure	320 bar
Secondary Pump	Kawasaki K3VL45 cc Axial piston, variable displacement, pressure compensated with low pressure standby
Max Flow	99 L/m
Maximum Pressure	320 bar
Auxiliary Pump-1	Kawasaki K3VL28 cc Axial piston, variable displacement load sensing, pressure compensated with low pressure standby.
Max Flow	61 L/m
Maximum Pressure	320 bar
Auxiliary Pump-2	Gear Pump
Max Flow	40 L/m
Maximum Pressure	220 bar
Auxiliary Pump-3	Gear Pump
Max Flow	40 L/m
Maximum Pressure	220 bar
Drill Mast And Feed System	
Feed Stroke	3.8 m
Pull Capacity @ 200 bar	22,600 kg
Thrust Capacity @ 200 bar	12,600 kg
Rod Pull	3 or 6 m
Drilling Angle	45° off horizontal to 90° vertical down
Draw Works	
Main Line Hoist	Main Line Hoist Double speed motor
Hook Load (single part line) Bare Drum	18,140 kg
Hoisting Speed (single part line) Bare Drum	72 m/min and 40 m/min
Main Hoist Cable	22 mm
Minimum Breaking Strength	51000 kg
Foot Clamp Capacity	HWT
Wireline Hoist	
Rotation Motor	Danfoss OMV 400 cc/rev, hydraulic motor
Line Pull	
Bare Drum	990 kg
Full Drum	510 kg
Line Speed	
Bare Drum	145 m/min
Full Drum	284 m/min
Drum Capacity 4.8 mm (3/16") swaged	2500 m
Minimum Breaking Strength	2250 kg

YKM-2000 DIAMOND CORE DRILLING RIG TECHNICAL SPECS

Track System	
Track Model	AKS -22
Maximum Dynamic Capacity	12000 kg
Track Type	400 mm wide triple grouser steel track shoes

RQ-535 Triplex Mud Pump	
Rotation Motor	100 cc/rev, hydraulic motor
Max. Flow Rate	270 L/m
Working Pressure	36 Bar
Max. Pressure	49 Bar

FOOT ROD HOLDER	
Type	Hydraulically open, Gas Spring Closed
Max. Inside diameter	140mm
Holding Capacity	20,000 kg

Mud Mixer	
Hydraulically Powered Mud Mixer	
Maximum R.P.M. of Mud Mixer Shaft at Full Flow	2300

One ER-2000 Drilling Rig Consist of:
Undercarrige (AKS-22 Track System)
Power Unit Group Cummins 6LTAA8.9-C360, 6 cylinder, 360 hp
Hydraulic Module: 420 L Oil Tank and Filtering System, Hydraulic Pumps and Motors, Control Panel
Hot Weather Hydraulic Cooling Group
Hydraulically Driven PQ Head Oil Cooling and Circulation System
Rotation Unit Grp. c/w PQ Nitro Chuck/Head Guard
Draw Works Grp. c/w 19 Ton Main Line Hoist with Cable, Wireline Hoist less Cable
Hydraulic Mast Raising
Hydraulic Mast Dump
Telescopic Mast Assembly
Hydraulic Leveling Jacks
Base Frame and Fuel Tank (300 L)
Diesel Engine Display and Control Panel
Lighting System and 12V Battery
535 Mud Pump and Mud Circulation System
Mud Mixer
Foot Rod-Holder
Rod Rack Platform
Access Stairs

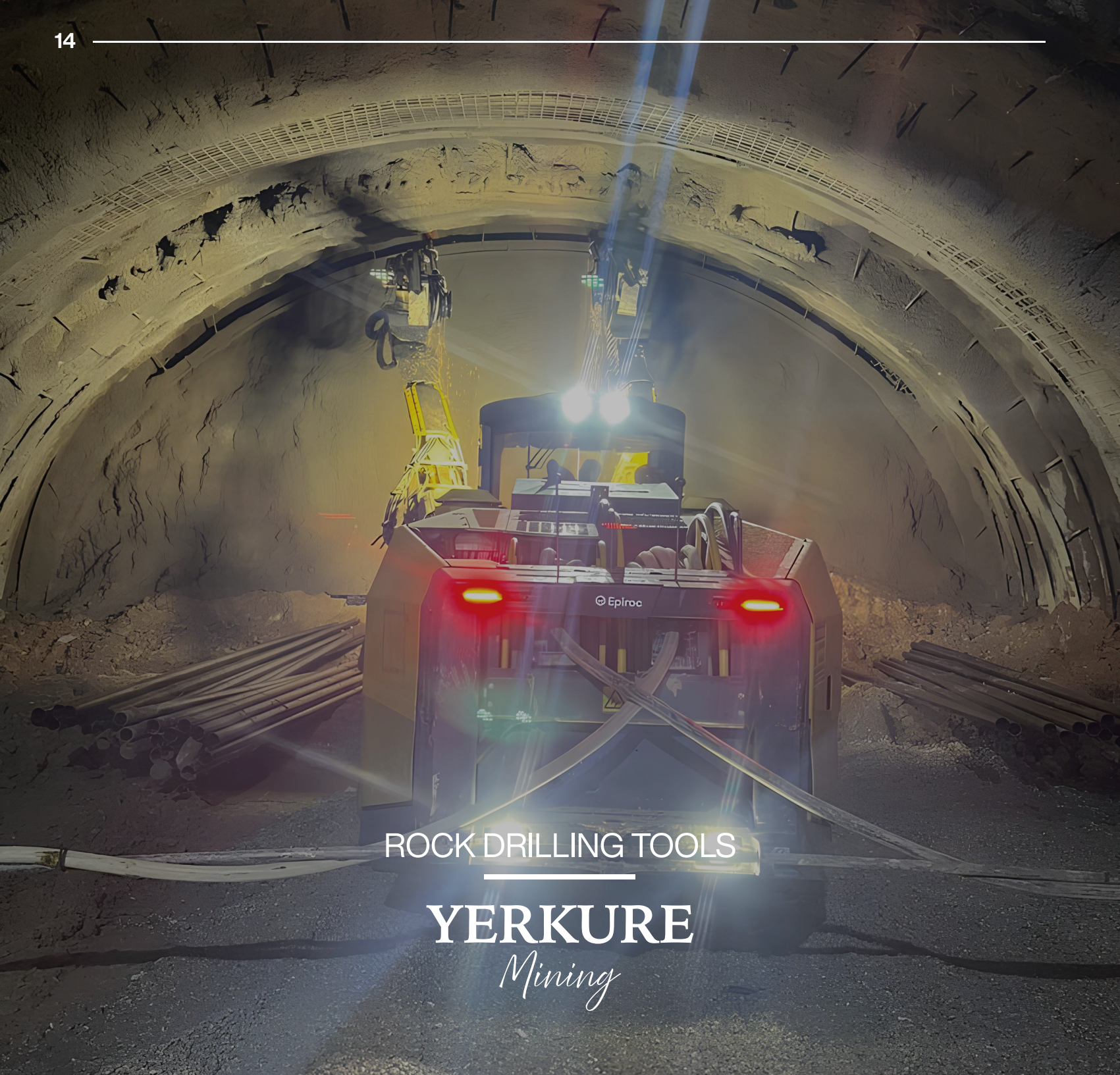

ROCK DRILLING TOOLS

YERKURE

Mining

R22 (7/8") Thread Bits

Button Bit - Regular		BIT diameter		Buttons Qty x Size, mm		Angle	Flushing Hole	
MM	Inch	MM	Inch	Gauge	Face		Face	Side
38	1 1/2"	4x9	2x8	25°	2	0		
38	1 1/2"	5x9	2x7	30°	1	1		
41	1 5/8"	5x9	2x8	30°	1	1		
48	1 7/8"	5x11	2x8	30°	1	2		

R25 (1") Thread Bits

Button Bit - Regular		BIT diameter		Buttons Qty x Size, mm		Angle	Flushing Hole	
MM	Inch	MM	Inch	Gauge	Face		Face	Side
33	1 5/16"	5x7	2x7	45°	1	1		
35	1 3/8"	5x9	2x7	25°	1	1		
35	1 3/8"	5x8	2x7	35°	1	1		
38	1 1/2"	5x9	2x7	30°	1	1		
38	1 1/2"	5x9	2x7	25°	1	1		
41	1 5/8"	5x9	2x8	30°	1	1		
45	1 3/4"	5x11	2x8	30°	1	2		
45	1 3/4"	6x10	3x8	25°	3	1		
48	1 7/8"	6x10	3x8	30°	3	1		
51	2"	6x10	3x9	30°	3	1		

Button Bit - Retrac		BIT diameter		Buttons Qty x Size, mm		Angle	Flushing Hole	
MM	Inch	MM	Inch	Gauge	Face		Face	Side
51	2"	6x10	3x9	30°	3	0		
51	2"	6x10	3x9	30°	3	0		

R28 (1 1/8") Thread Bits

Button Bit - Regular		BIT diameter		Buttons Qty x Size, mm		Angle	Flushing Hole	
MM	Inch	MM	Inch	Gauge	Face		Face	Side
38	1 1/2"	5x9	2x7	30°	1	1		
41	1 5/8"	5x9	2x8	30°	1	1		
48	1 7/8"	6x10	3x8	30°	3	1		
48	1 7/8"	6x9	3x9	30°	3	1		
51	2"	6x10	3x9	30°	3	1		

R32 (1 1/4") Thread Bits

Button Bit - Regular		BIT diameter		Buttons Qty x Size, mm		Angle	Flushing Hole	
MM	Inch	MM	Inch	Gauge	Face		Face	Side
41	1 5/8"	5x9	2x8	30°	1	2		
43	1 11/16"	6x9	3x8	30°	3	1		
43	1 11/16"	5x10	2x8	35°	1	2		
45	1 3/4"	6x10	3x8	25°	3	1		
45	1 3/4"	5x11	2x8	30°	1	2		
48	1 7/8"	5x11	2x8	30°	1	2		
48	1 7/8"	6x10	3x8	30°	3	1		
51	2"	6x10	3x9	30°	3	1		
51	2"	6x11	2x9	30°	2	2		
57	2 1/4"	6x11	3x10	30°	3	1		
60	2 3/8"	6x11	3x10	35°	3	1		
60	2 3/8"	6x11	3x10	35°	3	1		
64	2 1/2"	8x10	4x9	30°	2	0		
64	2 1/2"	6x12	3x11	30°	1	1		
76	3"	8x11	4x11	35°	2	0		
76	3"	8x12	5x11	35°	2	2		
102	4"	8x12	6x12	35°	2	1		
106	4 1/6"	8x14	6x12	35°	2	1		

R32 (1 1/4") Thread Bits

Button Bit - Retrac		BIT diameter		Buttons Qty x Size, mm		Angle	Flushing Hole	
MM	Inch	MM	Inch	Gauge	Face		Face	Side
45	1 3/4"	6x9	3x8	35°	3	0		
51	2"	6x10	3x9	30°	3	0		
51	2"	6x10	3x9	35°	3	0		
57	2 1/4"	6x11	3x9	30°	3	0		
60	2 3/8"	6x10	4x9	35°	3	0		
64	2 1/2"	6x12	3x10	35°	1	1		
64	2 1/2"	6x11	4x9	35°	3	0		
64	2 1/2"	6x12	4x10	30°	3	0		
64	2 1/2"	8x10	4x9	30°	2	0		

Dome Bits

DIA		Thread	No. of Gauge Buttons Qty X Size	No. of Face Buttons Qty X Size	Flush Holes	
MM	Inch				Face	Side
89	3 1/2"	R32	8X13	7X13	2	2
102	4"	R32	8X13	9X13	2	2

Reaming Bits 12° Taper

Diameter		No. of Gauge Buttons Qty X Size	No. of Face Buttons Qty X Size	Angle
MM	Inch			
89	3 1/2"	8X12	4X10	35°
102	4"	8X12	4X12	35°

Pilot Adapter 12° Taper

Insert Width	Thread
40	R32

R38 (1 1/2") Thread Bits

Button Bit - Regular		BIT diameter		Buttons Qty x Size, mm		Angle	Flushing Hole	
MM	Inch	MM	Inch	Gauge	Face		Face	Side
64	2 1/2"	8x10	4x9	30°	2	0		
64	2 1/2"	8x10	4x10	30°	2	2		
70	2 3/4"	6x11	4x11	30°	3	0		
76	3"	8x11	4x11	35°	2	2		

Button Bit - Retrac

Button Bit - Retrac		BIT diameter		Buttons Qty x Size, mm		Angle	Flushing Hole	
MM	Inch	MM	Inch	Gauge	Face		Face	Side
64	2 1/2"	6x12	3x10	35°	1	1		
68	2 2/3"	6x12	4x10	35°	3	0		
115	4 1/2"	8x14	7x12	35°	4	0		

T35 (1 1/3") Thread Bits

Button Bit - Regular		BIT diameter		Buttons Qty x Size, mm		Angle	Flushing Hole	
MM	Inch	MM	Inch	Gauge	Face		Face	Side
51	2"	6x10	3x9	30°	3	1		
54	2 1/8"	5x12	2x10	30°	2	1		

T38 (1 1/2") Thread Bits

Button Bit - Regular

BIT diameter	BIT diameter		Buttons Qty x Size, mm		Angle	Flushing Hole	
	MM	Inch	Gauge	Face		Face	Side
64	2 1/2"		6x12	3x11	30°	3	0
68	2 2/3"		8x10	4x10	30°	2	2
70	2 3/4"		7x12	4x10	35°	3	0
76	3"		8x12	5x11	35°	2	2
76	3"		7x12	4x11	35°	3	0
89	3 1/2"		8x12	6x12	35°	2	2
102	4"		8x14	5x14	35°	2	0
127	5"		8x16	7x14	35°	2	0

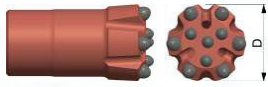

Button Bit - Retrac

BIT diameter	BIT diameter		Buttons Qty x Size, mm		Angle	Flushing Hole	
	MM	Inch	Gauge	Face		Face	Side
64	2 1/2"		6x11	4x10	35°	3	0
76	3"		6x12	4x11	35°	3	0
76	3"		7x12	4x11	35°	3	0
76	3"		8x12	4x11	35°	2	1
89	3 1/2"		9x12	6x12	35°	3	0
95	3 3/4"		8x11	6x11	35°	4	1
105	4 1/6"		8x12	6x11	35°	4	1

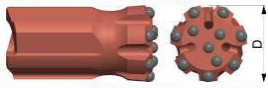

T45 (1 3/4") Thread Bits

Button Bit - Regular

BIT diameter	BIT diameter		Buttons Qty x Size, mm		Angle	Flushing Hole	
	MM	Inch	Gauge	Face		Face	Side
70	2 3/4"		7x12	4x10	35°	3	0
76	3"		7x11	5x10	35°	3	0
76	3"		8x12	5x11	35°	2	2
85	3 11/32"		8x12	6x11	35°	2	2
89	3 1/2"		6x13	5x12	35°	3	0
89	3 1/2"		8x12	6x12	35°	2	2
89	3 1/2"		9x12	6x11	35°	3	0
102	4"		8x14	6x13	35°	4	0
102	4"		9x14	7x12	35°	3	0
105	4 1/6"		8x14	6x13	35°	2	2
115	4 1/2"		8x14	8x12	35°	2	0
115	4 1/2"		9x14	9x12	35°	3	0

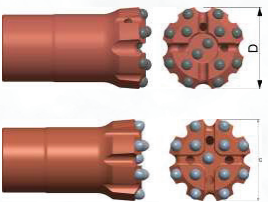

Button Bit - Retrac

BIT diameter	BIT diameter		Buttons Qty x Size, mm		Angle	Flushing Hole	
	MM	Inch	Gauge	Face		Face	Side
76	3"		8x11	4x11	35°	2	0
89	3 1/2"		8x14	6x12	35°	2	0
89	3 1/2"		8x12	4x12,2x11	35°	4	0
95	3 3/4"		8x13	6x12	35°	4	1
102	4"		8x12	7x12	35°	2	0
102	4"		8x14	4x13,2x12	35°	4	0
105	4 1/6"		8x12	6x11	35°	4	1
107	4 1/6"		8x12	6x11	35°	4	1
110	4 1/3"		8x12	7x12	35°	4	1
115	4 1/2"		8x14	6x12	35°	4	0
127	5"		8x14	7x13	35°	4	0
140	5 1/2"		8x14	7x14	35°	4	0
140	5 1/2"		9x16	9x14	35°	3	0
146	5 3/4"		8x14	8x14	35°	4	0
146	5 3/4"		9x14	9x14	35°	3	0
152	6"		9x16	6x14,4x13	35°	3	0
152	6"		8x14	8x14	35°	4	0

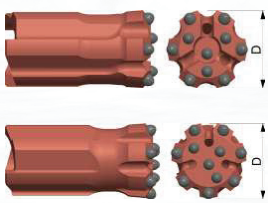

T45 Thread Bits

Dome Reaming Bit

BIT diameter	BIT diameter		Pilot Dia	Buttons Qty x Size, mm		Flushing Hole
	MM	Inch		MM	Gauge	
102	4"		57	8x12	4x12	4
127	5"		64	8x14	4x14	4
152	6"		64	8x14	8x14	4



T51 (2") Thread Bits

Button Bit - Regular

BIT diameter	BIT diameter		Buttons Qty x Size, mm		Angle	Flushing Hole	
	MM	Inch	Gauge	Face		Face	Side
89	3 1/2"		6x13	5x12	35°	3	1
89	3 1/2"		8x12	6x12	35°	2	2
89	3 1/2"		8x12	6x12	35°	4	2
89	3 1/2"		9x11	6x12	35°	3	1
102	4"		8x14	6x13	35°	2	2
102	4"		6x19	4x14	35°	2	0
102	4"		8x14	6x13	35°	4	0
115	4 1/2"		10x14	7x14	30°	3	0
115	4 1/2"		8x14	7x13	35°	2	0
115	4 1/2"		8x16	6x14	35°	4	0
115	4 1/2"		7x19	5x14	35°	2	0
127	5"		8x16	6x14	35°	4	0
127	5"		8x16	7x14	35°	2	0
127	5"		8x16	6x16	35°	2	2
140	5 1/2"		8x16	8x14	35°	2	0
152	6"		8x16	4x16,4x14	35°	4	0

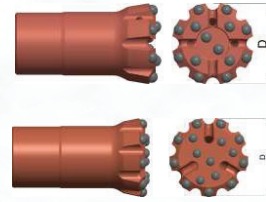

T51 (2") Thread Bits

Button Bit - Retrac

BIT diameter	BIT diameter		Buttons Qty x Size, mm		Angle	Flushing Hole	
	MM	Inch	Gauge	Face		Face	Side
89	3 1/2"		6x11	6x10	35°	3	1
89	3 1/2"		6x13	5x12	35°	3	1
89	3 1/2"		8x13	6x12	35°	2	1
89	3 1/2"		8x14	6x12	35°	2	0
89	3 1/2"		8x12	4x12,2x11	35°	4	0
89	3 1/2"		9x13	6x11	35°	3	1
92	3 5/8"		8x13	6x12	35°	2	0
95	3 3/4"		9x13	6x12	35°	3	0
102	4"		8x14	4x13	35°	4	0
102	4"		8x14	6x13	35°	2	2
102	4"		8x12	7x11	35°	4	0
102	4"		9x13	6x13	35°	3	1
105	4 1/6"		8x12	6x11	35°	4	1
107	4 1/6"		8x12	6x11	35°	4	1
115	4 1/2"		8x14	4x14,2x12	35°	4	0
115	4 1/2"		8x14	8x12	35°	2	0
115	4 1/2"		8x16	6x14	35°	4	0
127	5"		8x16	6x16	35°	2	2
127	5"		8x14	7x14	35°	4	0
140	5 1/2"		8x14	7x14	35°	4	0
146	5 3/4"		8x14	8x14	35°	4	0
146	5 3/4"		9x16	9x14	35°	3	0
152	6"		8x14	8x14	35°	4	0

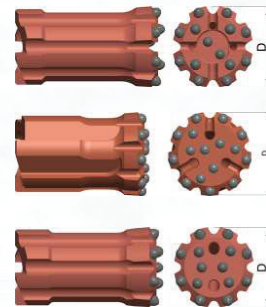

STANDARD COUPLING SLEEVE

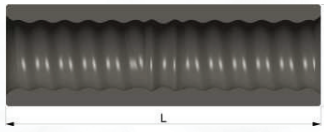

Thread Type		Dia	Length
R22		31	140
R25		35	160
R32		44	150
R38		55	170
T38		55	170
T38		55	190
T45		63	210
T51		77	235
T51		71	235

REDUCTION COUPLING SLEEVE



Thread Type		Dia	Length
F1	F2		
R32	R25	44	150
R32	R28	44	165
R38	R32	55	170
T38	R32	55	195
T38	R38	55	185
T45	T38	58	180
T45	T38	61	180
T51	T45	71	218

BIT ADAPTERS



Thread Type		Dia	Length
F	M		
R25	R32	45	173
R28	R32	40	230
R32	R38	45	225
R32	T38	45	225
T35	T38	48	250
R38	R32	55	270
T38	R32	57	270
T38	T45	57	285
T45	T38	63	265
T45	T51	63	285
T51	T45	71	285

COUPLING SLEEVE TYPE

STANDARD COUPLING SLEEVE

This coupling sleeve is very common in the industry standard. It connects two female threads like R32 - R32, T38-T38 etc.

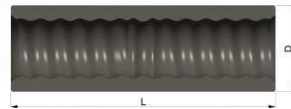

REDUCTION COUPLING SLEEVE

Reduction coupling sleeve is very common in the industry. It connects two different female threads like R32 - R38, T45-T38, T51-T38 etc.



EXTENSION RODS R32-ROUND32-R32 MM

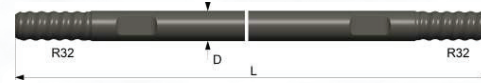

Length	Length		DIA (D)
	MM	FT	
915		3'	32
1220		4'	32
1525		5'	32
1600		5' 3"	32
1830		6'	32
2095		6' 10 1/2"	32
2435		8'	32
3050		10'	32
3660		12'	32

EXTENSION RODS R38-ROUND39-R38 MM

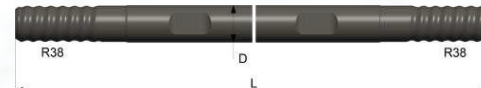

Length	Length		DIA (D)
	MM	FT	
1220		4'	39
1830		6'	39
2435		8'	39
3050		10'	39

EXTENSION RODS T38-ROUND39-T38 MM

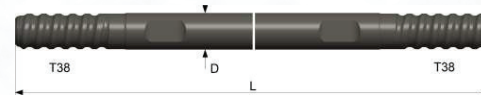

Length	Length		DIA (D)
	MM	FT	
1220		4'	39
2435		8'	39
3050		10'	39
3660		12'	39

EXTENSION RODS T45-ROUND46-T45 MM

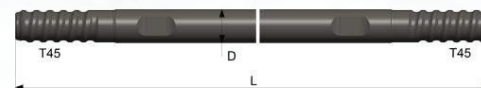

Length	Length		DIA (D)
	MM	FT	
1220		4'	46
1525		5'	46
2435		8'	46
3050		10'	46
3660		12'	46

EXTENSION RODS T51-ROUND52-T51 MM



Length	Length		DIA (D)
	MM	FT	
1220		4'	52
2435		8'	52
3050		10'	52
3660		12'	52

EXTENSION RODS MALE-FEMALE

EXTENSION RODS R32-ROUND32-R32 MF

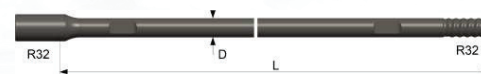

Length	Length		DIA (D)
	MM	FT	
915		3'	32
1220		4'	32
1830		6'	32
2095		6' 10 1/2"	32
2435		8'	32
3050		10'	32
3660		12'	32

EXTENSION RODS T35-ROUND39-T35 MF

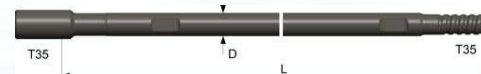

Length	Length		DIA (D)
	MM	FT	
1220		4'	39
3050		10'	39
3660		12'	39

EXTENSION RODS T38-ROUND39-T38 MF

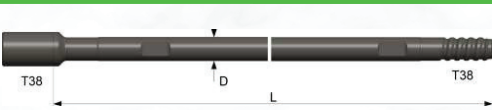

Length	Length		DIA (D)
	MM	FT	
1220	4'	39	
1525	5'	39	
1830	6'	39	
2095	6' 10 1/2"	39	
2435	8'	39	
3050	10'	39	
3660	12'	39	
4265	14'	39	

EXTENSION RODS T45-ROUND46-T45 MF

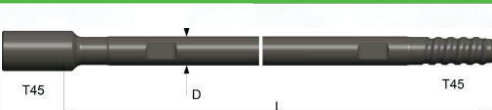

Length	Length		DIA (D)
	MM	FT	
1220	4'	46	
1525	5'	46	
1830	6'	46	
2095	6' 10 1/2"	46	
2435	8'	46	
3050	10'	46	
3660	12'	46	
4265	14'	46	

EXTENSION RODS T51-ROUND52-T51 MF

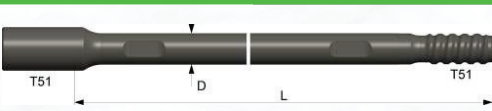

Length	Length		DIA (D)
	MM	FT	
1220	4'	52	
1525	5'	52	
1830	6'	52	
2095	6' 10 1/2"	52	
2435	8'	52	
3050	10'	52	
3660	12'	52	
4265	14'	52	

EXTENSION ROD ST61/GT60-ROUND60-ST61/GT60 MF

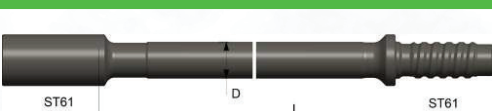

Length	Length		DIA (D)
	MM	FT	
1830	6'	60	
3050	10'	60	
3660	12'	60	
4265	14'	60	

DRIFTING & TUNNELING TOOLS

Bolting Rods R25-HEX25-R25



Length	Length		HEX
	MM	FT	
1220	4'	25	
1830	6'	25	
2175	7' 1 5/8"	25	
2475	8' 1 1/2"	25	
3090	10' 1 5/8"	25	
3700	12' 1 5/8"	25	

Bolting Rods R32-HEX25-R25

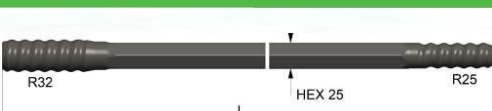

Length	Length		HEX
	MM	FT	
1220	4'	25	
1830	6'	25	
2000	6' 7"	25	
2175	7' 1 5/8"	25	
2475	8' 1 1/2"	25	
2785	9' 1 5/8"	25	
3090	10' 1 5/8"	25	
3700	12' 1 5/8"	25	

Drifter Rods R32-HEX32-R28



Length	Length		HEX
	MM	FT	
3090	10' 1 5/8"	32	
3700	12' 1 5/8"	32	

Drifter Rods R38-HEX32-R28



Length	Length		HEX
	MM	FT	
3090	10' 1 5/8"	32	
3700	12' 1 5/8"	32	

Drifter Rods R38-HEX32-R32



Length	Length		HEX
	MM	FT	
2475	8' 1 1/2"	32	
3090	10' 1 5/8"	32	
3700	12' 1 5/8"	32	
4305	14' 1 1/2"	32	

Drifter Rods T38-HEX32-R32



Length	Length		HEX
	MM	FT	
3090	10' 1 5/8"	32	
3700	12' 1 5/8"	32	
4305	14' 1 1/2"	32	

Drifter Rods R38-HEX35-R32

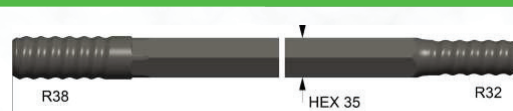

Length	Length		HEX
	MM	FT	
2475	8' 1 1/2"	35	
3090	10' 1 5/8"	35	
3700	12' 1 5/8"	35	
4305	14' 1 1/2"	35	

Drifter Rods R38-HEX35-R28



Length	Length		HEX
	MM	FT	
2475	8' 1 1/2"	35	
3090	10' 1 5/8"	35	
3700	12' 1 5/8"	35	
4305	14' 1 1/2"	35	

Drifter Rods T38-HEX35-R32

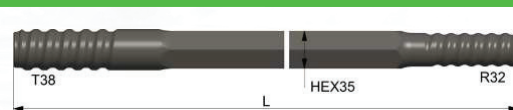

Length	Length		HEX
	MM	FT	
2475	8' 1 1/2"	35	
3090	10' 1 5/8"	35	
3700	12' 1 5/8"	35	
4305	14' 1 1/2"	35	

Drifter Rods T38-HEX35-T35



Length	Length		HEX
	MM	FT	
2475	8' 1 1/2"	35	
3090	10' 1 5/8"	35	
4305	14' 1 1/2"	35	

Drifter Rods T38-HEX35-T38

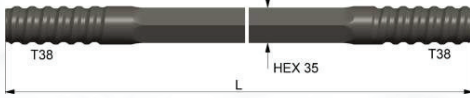

Length		HEX
MM	FT	
2475	8' 1 1/2"	35
3090	10' 1 5/8"	35
3700	12' 1 5/8"	35
4305	14' 1 1/2"	35

Drifter Rods R22-HEX25-R25 MF



Length		HEX
MM	FT	
567	1' 10 1/3"	25

GUIDE TUBES

T38 GUIDE TUBE



Length		DIA (D)
MM	FT	
1220	4'	56
1525	5'	56
1830	6'	56

T45 GUIDE TUBE

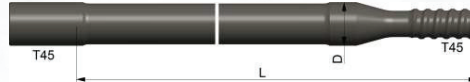

Length		DIA (D)
MM	FT	
1220	4'	64
1830	6'	64
3050	10'	64
3660	12'	64
3660	12'	76

T51 GUIDE TUBE

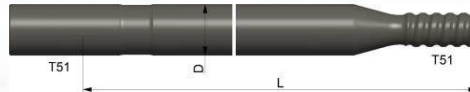

Length		DIA (D)
MM	FT	
1830	6'	76
3050	10'	76
3660	12'	76
3660	12'	87

DRILL TUBES

ST58 DRILL TUBE

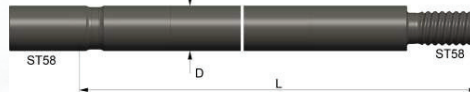

Length		DIA (D)
MM	FT	
1525	5'	76
1830	6'	76

ST61/GT60 DRILL TUBE

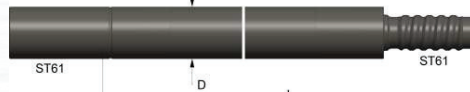

Length		DIA (D)
MM	FT	
4265	14'	87

ST68 DRILL TUBE



Length		DIA (D)
MM	FT	
1525	5'	87
1830	6'	87

Atlas Copco COP 125 / COP 130 / COP 131

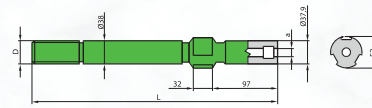

Thread	Diameter (mm)	Length (mm)	Flushing hole (mm)	Weight (kg)
R32	38	415	14	2,7
R38	38	380	14	2,9
T38	38	380	14	2,9
T45	38	380	14	3,0

Atlas Copco COP 1028

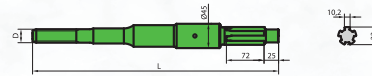

Thread	Diameter (mm)	Length (mm)	Flushing hole (mm)	Weight (kg)
R25	45	400	-	2,6
R28	45	400	-	2,7
R32	45	400	-	2,8

Atlas Copco COP 1028 HD

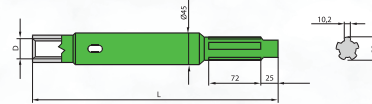

Thread	Diameter (mm)	Length (mm)	Flushing hole (mm)	Weight (kg)
R28	45	245	-	1,7

Atlas Copco COP 1036 / COP 1038 HB / COP 1038 HD / COP 1238 HF / COP 1238 LE / COP 1238 ME

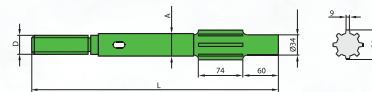

Thread	Diameter (mm)	Length (mm)	Flushing hole (mm)	Weight (kg)
R25	38	485	-	3,8
R32	38	485	-	4,0
R32	38	500	-	4,1
R32	38	575	-	4,7
R38	38	462	-	3,9
R38	38	485	-	4,1
R38	38	500	-	4,2
T38	38	485	-	4,1
T38	38	500	-	4,2
T38	38	590	-	4,9
T45	45	500	-	5,4
T45	45	575	-	6,0

Atlas Copco COP 1038 HL / COP 1238

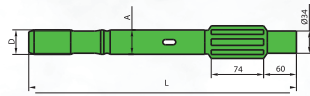

Thread	Diameter (mm)	Length (mm)	Flushing hole (mm)	Weight (kg)
R32	38	575	-	4,7
T38	38	575	-	4,8
T45	45	575	-	6,0

Atlas Copco COP 1132

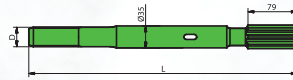

Thread	Diameter (mm)	Length (mm)	Flushing hole (mm)	Weight (kg)
R28	35	410	-	2,4
R32	35	410	-	2,5

Atlas Copco COP 1140

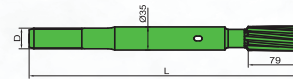

Thread	Diameter (mm)	Length (mm)	Flushing hole (mm)	Weight (kg)
R32	35	410	-	2,6

Atlas Copco COP 1238

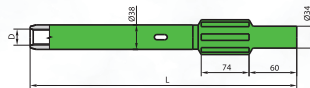

Thread	Diameter (mm)	Length (mm)	Flushing hole (mm)	Weight (kg)
R25	38	485	-	3,8

Atlas Copco COP 1432 F



Thread	Diameter (mm)	Length (mm)	Flushing hole (mm)	Weight (kg)
R32	55	341	-	4,2
R38	55	341	-	4,4
T38	55	341	-	4,4

Atlas Copco COP 1432 / COP 1440 /
COP 1532 / COP 1838 HD

Thread	Diameter (mm)	Length (mm)	Flushing hole (mm)	Weight (kg)
R32	38	435	-	4,0
R32	38	525	-	4,0
R38	38	435	-	4,0
R38	38	455	-	4,1
R38	38	525	-	4,7
T38	38	435	-	4,0
T38	38	525	-	5,7

Atlas Copco COP 1440 / COP 1550 / COP 1838

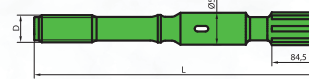

Thread	Diameter (mm)	Length (mm)	Flushing hole (mm)	Weight (kg)
R32	52	525	-	5,8
R38	52	525	-	6,0
T38	52	525	-	6,0
T45	52	525	-	6,7
T51	52	525	-	6,8

Atlas Copco COP 1838 Extractor



Thread	Diameter (mm)	Length (mm)	Flushing hole (mm)	Weight (kg)
T45	60	730	-	10,1
T51	60	730	-	10,5

Atlas Copco COP 1440 / COP 1838

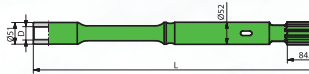

Thread	Diameter (mm)	Length (mm)	Flushing hole (mm)	Weight (kg)
R32	52	640	-	7,5
R38	52	650	-	7,9

Atlas Copco COP 1440 / COP 1838

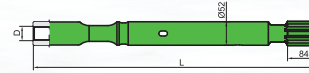

Thread	Diameter (mm)	Length (mm)	Flushing hole (mm)	Weight (kg)
R32	52	640	-	9,1
R38	52	650	-	8,9

Atlas Copco COP 1640 / COP 1840

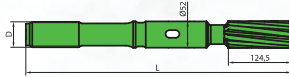

Thread	Diameter (mm)	Length (mm)	Flushing hole (mm)	Weight (kg)
T38	52	565	-	7,0
T45	52	565	-	7,2
T51	52	565	-	7,6

Atlas Copco COP 1840 Ex / COP 1850 Ex /
COP 2150 Ex / COP 2550 Ex

Thread	Diameter (mm)	Length (mm)	Flushing hole (mm)	Weight (kg)
T45	60	770	-	11,4
T51	60	770	-	12,2

Atlas Copco COP 2160 / COP 2560

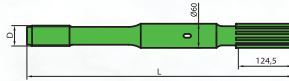

Thread	Diameter (mm)	Length (mm)	Flushing hole (mm)	Weight (kg)
T45	60	770	-	10,9
T51	60	770	-	11
T60	60	770	-	12,4

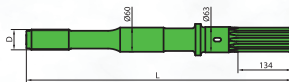
Atlas Copco COP 2160 Extractor /
COP 2560 Extractor

Thread	Diameter (mm)	Length (mm)	Flushing hole (mm)	Weight (kg)
T45	63	770	-	13,2
T51	63	770	-	13,3
T60	63	770	-	14,0
GT60	63	770	-	14,0

EPIROC COP 2560EX, 2560EX+, SC25-HE

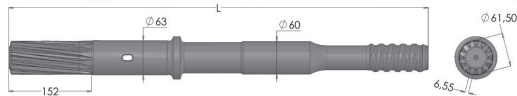

5.27

T45	770	448089
T51	770	448091
XT51	770	448092
T-WiZ60	770	448094

Furukawa HD 150

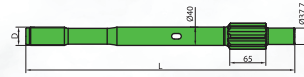

Thread	Diameter (mm)	Length (mm)	Flushing hole (mm)	Weight (kg)
R38	40	520	-	4,95

Furukawa HD 300

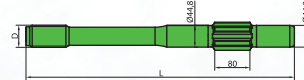

Thread	Diameter (mm)	Length (mm)	Flushing hole (mm)	Weight (kg)
T45	44.8	655	16	6,70

Furukawa HCR 9-DS / HD 609



Thread	Diameter (mm)	Length (mm)	Flushing hole (mm)	Weight (kg)
T38	45	690	-	6,4

Furukawa HD 609RP

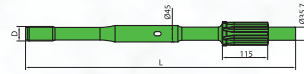

Thread	Diameter (mm)	Length (mm)	Flushing hole (mm)	Weight (kg)
T38	44.8	795	-	7,80

Furukawa HD 612

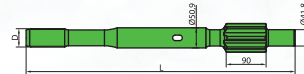

Thread	Diameter (mm)	Length (mm)	Flushing hole (mm)	Weight (kg)
T45	50,9	670	-	8,55
T51	50,9	670	-	8,70

Furukawa HD 612RP

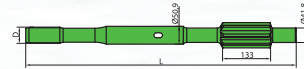

Thread	Diameter (mm)	Length (mm)	Flushing hole (mm)	Weight (kg)
T45	50,9	845	-	10,60
T51	50,9	845	-	10,80

Furukawa HD 615

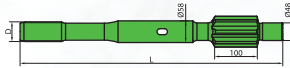

Thread	Diameter (mm)	Length (mm)	Flushing hole (mm)	Weight (kg)
T45	58	700	-	10,6
T51	58	700	-	10,8

Furukawa HD 615RP

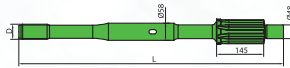

Thread	Diameter (mm)	Length (mm)	Flushing hole (mm)	Weight (kg)
T45	58	877	-	15,0
T51	58	877	-	15,4

Furukawa HD 709

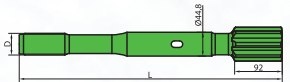

Thread	Diameter (mm)	Length (mm)	Flushing hole (mm)	Weight (kg)
T38	44,8	620	-	6,75
T45	44,8	620	-	6,80

Furukawa HD 709RP

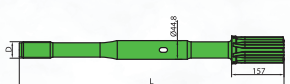

Thread	Diameter (mm)	Length (mm)	Flushing hole (mm)	Weight (kg)
T38	44,8	785	-	8,85
T45	44,8	785	-	8,90

Furukawa HD 712



Thread	Diameter (mm)	Length (mm)	Flushing hole (mm)	Weight (kg)
T45	51	590	-	8,4
T51	51	590	-	8,8
T45	51	790	-	9,7
T51	51	790	-	9,9

Furukawa HD 712RP

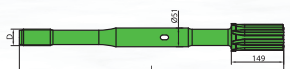

Thread	Diameter (mm)	Length (mm)	Flushing hole (mm)	Weight (kg)
T45	51	850	-	12,0
T51	51	885	-	13,0

Furukawa HD 715

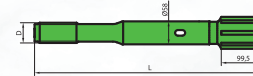

Thread	Diameter (mm)	Length (mm)	Flushing hole (mm)	Weight (kg)
T51	58	790	-	6,4

Furukawa HD 715 RP

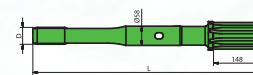

Thread	Diameter (mm)	Length (mm)	Flushing hole (mm)	Weight (kg)
T51	58	885	-	16,0

Gardner Denver HPR 2



Thread	Diameter (mm)	Length (mm)	Flushing hole (mm)	Weight (kg)
T51	50,7	914	-	14,0

Ingersoll Rand YH 65 / YH 70



Thread	Diameter (mm)	Length (mm)	Flushing hole (mm)	Weight (kg)
T38	45	500	19	5,2
T45	45	500	19	5,5

Ingersoll Rand YH 65 RP



Thread	Diameter (mm)	Length (mm)	Flushing hole (mm)	Weight (kg)
T38	45	700	19	7,8
T45	45	700	19	7,9

Ingersoll Rand YH 80 A

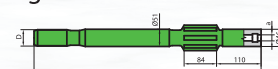

Thread	Diameter (mm)	Length (mm)	Flushing hole (mm)	Weight (kg)
T38	51	500	19	5,5
T45	51	500	19	5,7
T51	51	500	19	6,4

Krupp HB 101

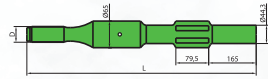

Thread	Diameter (mm)	Length (mm)	Flushing hole (mm)	Weight (kg)
T38	65	650	-	10,9

Krupp HB 101

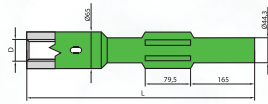

Thread	Diameter (mm)	Length (mm)	Flushing hole (mm)	Weight (kg)
R38	65	590	-	10,7
T38	65	590	-	10,7
T45	65	590	-	10,5

Montabert HC 40 / HC 50



Thread	Diameter (mm)	Length (mm)	Flushing hole (mm)	Weight (kg)
R32	38	370	-	3,0
R32	38	445	-	3,5
R38	38	370	-	3,3
R38	38	380	-	3,2
R38	38	445	-	4,0
T38	38	370	-	3,2
T38	38	445	-	3,8

Montabert HC 80 / HC 90 / HC 105

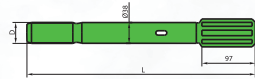

Thread	Diameter (mm)	Length (mm)	Flushing hole (mm)	Weight (kg)
R32	38	440	-	3,6
R38	38	440	-	3,9
T38	38	440	-	3,9

Montabert HC 80 RP / HC 120 RP

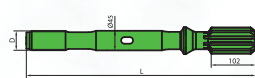

Thread	Diameter (mm)	Length (mm)	Flushing hole (mm)	Weight (kg)
T38	45	770	-	8,6
T45	45	670	-	7,5
T45	45	770	-	8,6

Montabert HC 109



Thread	Diameter (mm)	Length (mm)	Flushing hole (mm)	Weight (kg)
R32	45	530	-	5,6
R38	45	530	-	5,9
T38	45	530	-	5,9
T45	45	530	-	6,1

Sandvik – Tamrock HL 438 TS / HL 538

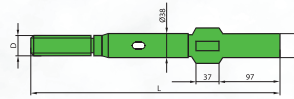

Thread	Diameter (mm)	Length (mm)	Flushing hole (mm)	Weight (kg)
R32	38	450	-	3,8
R38	38	450	-	4,4
R38	38	495	-	4,8
T38	38	450	-	4,4
T38	38	495	-	4,8
T38	38	545	-	5,2

Sandvik – Tamrock HL 500 / HL 500 S / HL 510 / HL 510 S

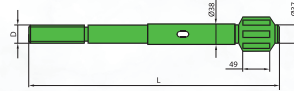

Thread	Diameter (mm)	Length (mm)	Flushing hole (mm)	Weight (kg)
R32	38	460	-	3,9
R32	38	550	-	4,3
R38	38	450	-	4,1
R38	38	460	-	4,2
R38	38	500	-	4,5
R38	38	550	-	4,6
T38	38	460	-	4,2
T38	38	500	-	4,5
T38	38	550	-	4,6

Sandvik – Tamrock HL 500 S



Thread	Diameter (mm)	Length (mm)	Flushing hole (mm)	Weight (kg)
R25	38	550	-	9,0

Sandvik – Tamrock HL 500 / HL 510

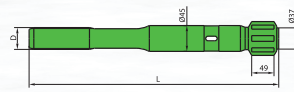

Thread	Diameter (mm)	Length (mm)	Flushing hole (mm)	Weight (kg)
R32	45	550	-	5,7
R38	45	500	-	5,4
T38	45	550	-	5,9
T45	45	550	-	6,2

Sandvik – Tamrock HL 600 / HL 600 S

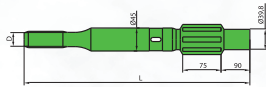

Thread	Diameter (mm)	Length (mm)	Flushing hole (mm)	Weight (kg)
R32	45	600	-	5,8
R38	45	525	-	5,6
T38	45	525	-	5,6
T38	45	600	-	6,0
T45	45	525	-	5,8
T45	45	600	-	6,4

Sandvik – Tamrock HL 645

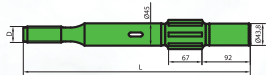

Thread	Diameter (mm)	Length (mm)	Flushing hole (mm)	Weight (kg)
R32	45	525	-	5,8
T38	45	600	-	6,3
T45	45	600	-	6,5

Sandvik – Tamrock HL 700 / HL 800

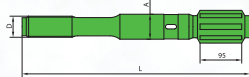

Thread	Diameter (mm)	Length (mm)	Flushing hole (mm)	Weight (kg)
T38	45	600	-	7,0
T45	45	600	-	7,2
T38	52	600	-	8,4
T45	52	600	-	8,8
T45	52	700	-	10,0
T51	52	600	-	9,2

Sandvik – Tamrock HL 1000

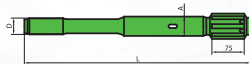

Thread	Diameter (mm)	Length (mm)	Flushing hole (mm)	Weight (kg)
T45	52	670	-	10,0
T51	52	590	-	9,3
T51	52	670	-	10,0
T60	60	670	-	12,7

Sandvik – Tamrock HL 1000

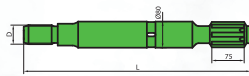

Thread	Diameter (mm)	Length (mm)	Flushing hole (mm)	Weight (kg)
ST58	80	635	-	18,4
ST68	80	640	-	18,8

Sandvik – Tamrock HL 1000

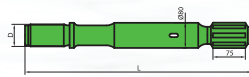

Thread	Diameter (mm)	Length (mm)	Flushing hole (mm)	Weight (kg)
GT60	80	670	-	19,5

Sandvik – Tamrock HL 1500

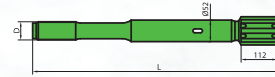

Thread	Diameter (mm)	Length (mm)	Flushing hole (mm)	Weight (kg)
T51	52	710	-	11,8

Sandvik – Tamrock HL 1500

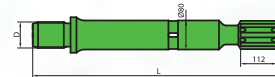

Thread	Diameter (mm)	Length (mm)	Flushing hole (mm)	Weight (kg)
ST58	80	635	-	18,1
ST68	80	635	-	18,3

Sandvik – Tamrock HL 1500 / HL 1560

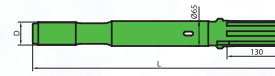

Thread	Diameter (mm)	Length (mm)	Flushing hole (mm)	Weight (kg)
T51	65	760	-	16,4
GT60	65	760	-	16,7

Sandvik – Tamrock HL 1500-80 / HL 1560-80

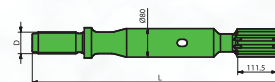

Thread	Diameter (mm)	Length (mm)	Flushing hole (mm)	Weight (kg)
GT60	80	760	-	21,5

Sandvik – Tamrock HL 1500-90 SPE

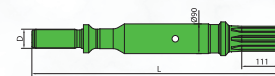

Thread	Diameter (mm)	Length (mm)	Flushing hole (mm)	Weight (kg)
GT60	90	760	-	25,9

Sandvik – Tamrock HLX 5

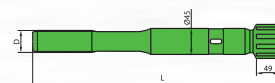

Thread	Diameter (mm)	Length (mm)	Flushing hole (mm)	Weight (kg)
R32	45	500	-	5,1
R38	45	500	-	5,4
T38	45	500	-	5,4
T45	45	575	-	6,4
R38	45	575	-	6,3

Sandvik – Tamrock HLX 5T

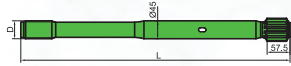

Thread	Diameter (mm)	Length (mm)	Flushing hole (mm)	Weight (kg)
T45	45	860	-	9,4

Sandvik – Tamrock HLX 5 PE-45



Thread	Diameter (mm)	Length (mm)	Flushing hole (mm)	Weight (kg)
R32	45	575	-	5,7
T38	45	720	-	7,6

Sandvik RD 520 / RD 525

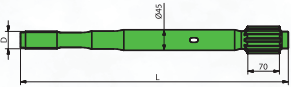

Thread	Diameter (mm)	Length (mm)	Flushing hole (mm)	Weight (kg)
T38	45	600	-	6,4
T38	45	745	-	7,7
R32	45	745	-	7,6
T45	45	880	-	9,9

Secoma Hydrastar 200

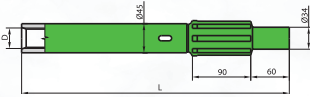

Thread	Diameter (mm)	Length (mm)	Flushing hole (mm)	Weight (kg)
R32	45	351	-	3,7

Soosan SP 3

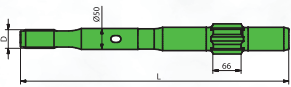

Thread	Diameter (mm)	Length (mm)	Flushing hole (mm)	Weight (kg)
T45	50	655	-	10,5

Toyo 650

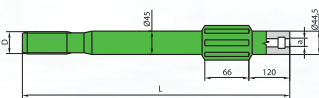

Thread	Diameter (mm)	Length (mm)	Flushing hole (mm)	Weight (kg)
T38	45	550	12	5,7



IN HOLE TOOLS &
MUD PRODUCTS & DIAMOND TOOLS

YERKURE
Mining

IN HOLE TOOLS / KUYU İÇİ EKİPMANLAR OTHER EQUIPMENT / DİĞER EKİPMANLAR

RING BIT / HALKA UÇ

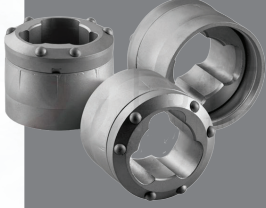

Generally, 89 or 114 mm diameter is preferred. It is the basic equipment that allows the excavation of the soil and advances in the soil. After the drilling process is completed, it is separated from the ring bit and removed from the soil and used again.

Genellikle 89 veya 114 mm çap tercih edilir. Toprağın kazılmasını sağlayan ve toprak içinde ilerleyen temel ekipmandır. Delme işlemi tamamlandıktan sonra ring bitten ayrılarak topraktan çıkar ve tekrar kullanılır.

PILOT BIT / KILAVUZ UÇ



Used with pilot bit. After the drilling process is completed, it remains in the soil.

Pilot bit ile birlikte kullanılır. Delme işlemi tamamlandıktan sonra toprağın içinde kalır.

ADAPTERS / ADAPTÖRLER



- Rod Adapters / Tij Adaptörleri
- Casing Adapters / Muhafaza Adaptörleri
- Water Swivel Adapters / Su Başlığı Adaptörleri
- Hoist Plug Adapters / Manevra Başlığı Adaptörleri
- Recovery Tap Adapters / Tahliyecici Adaptörleri
- Cutter Adapters / Rod Cutter Adaptörleri
- Blank Adapters / Blok Adaptörler

Adapters and subs are available in Male/Male and Male/Female types for rods, casings, and other tooling.

Adaptörler ve ara parçalar, tijler, muhafaza boruları ve diğer ekipmanlar için Erkek/Erkek ve Erkek/Dişi tiplerinde sunulmaktadır.

RECOVERY TOOLS / KURTARICI EKİPMANLAR



- Recovery Taps / Tahliyeciler
- Overshot Fishing Tools / Overshot Kurtarıcılar
- Cutters / Kesiciler

Recovery taps are available in various types with male / female options. Cutters are designed for rods and casings in a variety of sizes.

Tahliyeciler, kurtarılacak takımın kuyu içindeki durumuna ve vaziyetine bağlı olarak farklı tiplerde üretilebilir. Rod Cutter, kuyu içerisinde kalan tij ya da muhafazaları kesmek için özel bıçaklar kullanılarak tasarlanmıştır.

CORE BOXES / KAROT SANDIKLARI

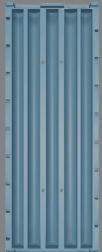

- Plastic Core Boxes / Plastik Karot Sandıkları
- Core Box Lids / Karot Sandığı Kapakları
- Core Box Separators / Karot Sandığı Ayraçlar
- Chip Boxes / Kırtı Kutuları

Crafted from high-quality, recycled plastic, these eco-friendly core boxes are available in sizes ranging from BQ to PQ. Each size is compatible with a single, specially designed lid for a secure fit.

Yüksek kaliteli geri dönüştürülmüş plastikten üretilen bu çevre dostu karot sandıkları, BQ'dan PQ'ya kadar farklı boyutlarda mevcuttur. Kapak dizaynı, her çapta sandıkla uyum sağlamak için özel olarak tasarlanmıştır.

ACCESSORIES / AKSESUARLAR



- Ridgid Pipe Wrenches / Ridgid Boru Anahtarları
- Core Hammers / Karot Çekicileri
- Wireline / Hoist Cable / Halatlar
- 135 Triplex Pump / 135/535 Çamur Pompaları
- Mud Mixer / Tank / Çamur Karıştırıcıları
- Protective Safety Equipment / İş Güvenliği Ekipmanları
- Drill Rig Spares / Makine Yedekleri

Our range of accessories includes essential tools and equipment to support your drilling operations.

Aksesuar yelpazemiz, sondaj çalışmalarınız için gerekli tüm araç ve ekipmanları içerir.

MUD PRODUCTS / ÇAMUR KİMYASALLARI ADDITIVES / KATKILAR

BENTONITE & WEIGHTING MATERIALS / BENTONİT VE AĞIRLAŞTIRICILAR



- YKM-GEL Drilling Bentonite / YKM-GEL Bentonit
- YKM-GEL HDD Bentonite / YKM-GEL HDD Bentonit
- Pellet Bentonite / Pelet Bentonit
- Barite / Barit

High-quality bentonite products are designed to enhance the performance of drilling operations. Used primarily for stabilizing boreholes and preventing the collapse of the walls, our bentonite products offer excellent viscosity, fluid loss control, and suspension properties.

Yüksek kaliteli bentonit ürünleri, sondaj operasyonlarının performansını artırmak için tasarlanmıştır. Özellikle sondaj kuyularını stabilize etmek ve kekin, formasyonun çökmesini önlemek için kullanılan bentonit ürünlerimiz mükemmel viskozite, filtrasyon özellikleri sunar.

FILTRATION / FİLTASYON / SU KAYBI



- AX-PAC [LV]
- AX-PAC [R]
- AX-PAC [HV]
- CMC [LV]
- CMC [HV]

Filtration additives, including PAC (Polyanionic Cellulose) and CMC (Carboxymethyl Cellulose), are essential for optimizing drilling fluid performance. These additives are designed to improve fluid loss control and enhance viscosity.

PAC (Poliyanionik Selüloz) ve CMC (Karboksümetil Selüloz) dahil olmak üzere filtrasyon katkıları, sondaj çamuru performansını optimize etmek için gereklidir. Bu katkı maddeleri su kaybı kontrolünü iyileştirmek, viskoziteyi artırmak için tasarlanmıştır.

LUBRICANTS / YAĞLAYICILAR



- YKM-PEN / YKM-Pen Takım Yağlayıcı
- YKM-Lube
- YKM-Rod Grease / YKM-Tij Gresi
- YKM-Thread Grease / YKM-Diş Gresi

Lubrication products are designed to enhance the performance and longevity of drilling equipment. From reducing friction to preventing wear and tear, our high-quality lubricants ensure smooth operation of drill rods, bits, and other critical components.

Yağlama ürünleri, sondaj ekipmanlarının performansını ve uzun ömürlülüğünü artırmak için tasarlanmıştır. Sürtünmeyi azaltmaktan aşınma ve yıpranmayı önlemeye kadar, yüksek kaliteli yağlayıcılarımız sondaj tijlerinin, matkapların ve diğer kritik bileşenlerin sorunsuz çalışmasını sağlar.

VISCOSITY / VİSKOZİTE VERİCİLER



- A-VIS Dry PHPA Polymer / A-VIS Toz PHPA Polimer
- A-VIS Liquid PHPA Polymer / A-VIS Sıvı PHPA Polimer

PHPA (Partially Hydrolyzed Polyacrylamide) polymer is a high-performance product designed to enhance the efficiency of drilling operations. Used primarily as a viscosity modifier, PHPA polymer helps improve fluid loss control and hole stability in water-based mud systems. It effectively reduces friction and promotes better cuttings removal, making it ideal for both exploration and geotechnical drilling.

PHPA polimer, sondaj işlemlerinin verimliliğini artırmak için tasarlanmış yüksek performanslı bir üründür. Özellikle viskozite artırıcı olarak kullanılan PHPA polimeri, su bazlı çamur sistemlerinde kil / şeyil birimlerini dengelemeye ve kuyu stabilitesini iyileştirmeye yardımcı olur. Sürtünmeyi etkili bir şekilde azaltır ve kırıntıların daha iyi şekilde atılmasını sağlar.

LOST CIRCULATION MATERIALS / KAÇAK KONTROL MADDELERİ



- AX-SEAL [F/M]
- AX-PLUG

LCM products are specially formulated to address and prevent fluid loss during drilling operations. Designed to seal fractures, porous formations, and other high-loss zones, LCM products help restore wellbore pressure and maintain the stability of the borehole. Whether you're dealing with mild or severe circulation loss, ensure that operations proceed smoothly, minimizing downtime and improving overall efficiency.

Kaçak kontrol ürünleri, sondaj işlemleri sırasında su kaybını gidermek ve önlemek için özel olarak formüle edilmiştir. Kırıklar, gözenekli oluşumlar ve diğer yüksek kayıplı bölgeleri kapatmak için tasarlanan ürünler, kuyu deliği basıncını geri kazanmaya ve sondaj deliğinin dengesini korumaya yardımcı olur.

OTHER ADDITIVES / DİĞER ÜRÜNLER

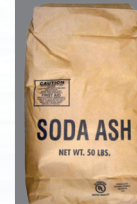

- Soda Ash / Soda Külü
- Caustic Soda / Kostik Soda
- YKM-Thinner / YKM-İnceltici
- PYKM-Foam / PYKM-Köpük
- Lignosulfonate / Lignosülfonat
- Calcium Carbonate / Kalsiyum Karbonat











These specialized products are essential for optimizing drilling operations across different drilling methods and formation conditions.

Bu özel ürünler, farklı koşullar altında sondaj operasyonlarını optimize etmek için gereklidir.

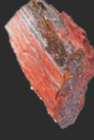

DIAMOND PRODUCTS / ELMAS ÜRÜNLER

DIAMOND DRILL BITS / ELMAS MATKAPLAR

DIAMOND BIT SELECTION

 <p>TALC HARD SHALES LIMESTONE SANDSTONE</p>	 <p>SCHIST DOLOMITE SERPENTINITE</p>	 <p>BASALT DIORITE DOLERITE</p>	 <p>GABBRO QUARTZ PEGMATITE</p>	 <p>DIORITE GRANITE GNEISS QUARTZITE ANDESITE</p>	 <p>GLASSY QUARTZITE RHYOLITE PORPHYRY GRANITE</p>	 <p>JASPILITE CHERT IRONSTONE</p>
 <p>BLUE BIT Mohs Hardness : 1 - 4 Abressive , Broken Formations</p>	 <p>GREEN BIT Mohs Hardness : 5 - 7 Abressive , Compotent / Broken Formations</p>	 <p>ORANGE BIT Mohs Hardness : 6 - 8 Abressive , Compotent / Broken Formations</p>	 <p>RED BIT Mohs Hardness : 8 - 9 Non-Abressive Compotent Formations</p>			

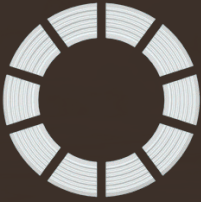
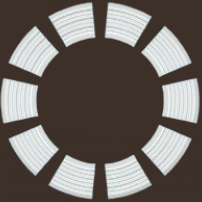
CROWN SELECTION

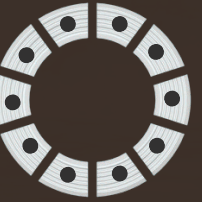
 <p>STANDART WW General purpose design for competent, broken, abrasive and non-abrasive formations</p>	 <p>WIDE WW Superior flushing capability. Suitable for both broken and component formations that requiring increased fluid flow</p>	 <p>TURBO WW Reduced contact area allows for increased penetration rates. High performance under low weight on the bit.</p>	 <p>FACE DISCHARGE Increases core recovery for difficult conditions where the core sample is susceptible to washing.</p>
--	---	--	--

DIAMOND TOOLS / ELMAS ÜRÜNLER OTHER TOOLING / DİĞER EKİPMANLAR

REAMING SHELLS / PORTKRONLAR



- Reaming Shell R / Elmas Portkron STD
- Reaming Shell Dual Pad / Elmas Portkron Çift Ped
- Rod Reaming Shell / Tij Portkronu

Apex provides a range of premium reaming shells designed to maintain hole direction, ensure proper hole gauge, and reduce premature wear on drilling tools caused by vibration. Our heavy-duty reaming shells are available in diamond-impregnated and surface-set configurations, offered in all standard DCDMA sizes to meet diverse drilling needs.

Kuyu eğimini, stabilitesini ve yönünü korumak için kullanılan portkron ürünlerimiz aynı zamanda kuyu titreşiminin neden olduğu hasarı önlemek ve aşındırmayı minimize etmek için tasarlanmıştır. Aşındırıcı yüzeylerde kullanılan elmaslar özenle seçilmiş ve uzun ömürlülük hedeflenmiştir.

CASING / ROD SHOES / ÇARIKLAR



- Diamond Crown C/S / Muhafaza Elmas Çarık
- Diamond Crown Rod Shoe / Tij Elmas Çarık
- Carbide Casing Shoe / Vidy e Çarık

Apex offers high-performance casing shoes designed to ensure smooth casing advancement and prevent snagging on borehole irregularities. Available in B, N, H, and P sizes, we also provide economy options for N and H sizes, as well as oversize options in N, H, and P to suit a variety of drilling requirements.

Doğrusal muhafaza ilerlemesi sağlamak ve sondaj deliği düzensizliklerinde takılmayı önlemek için tasarlanmış yüksek ömürlü muhafaza çarıkları N, H ve P çaplarında mevcut olup, tijler için de kullanılmak üzere farklı bağlantı seçenekleri ile sunulmaktadır.

PCD / PDC BITS / PCD / PDC BİTLER



- Coring PCD Bits / Karot Alır PCD
- Non-Coring PCD Bits / Kapalı PCD

Polycrystalline Diamond (PCD) Bits have a purpose-designed cast matrix head with 13.3 mm round PCD inserts fixed in a cutting pattern. Non-Core Bits are used for open hole drilling.

PCD Drill Bits have proven extremely successful in soft to medium-hard consolidated formations. They are used widely in coalfield exploration and open hole drilling to the zone of interest before core drilling commences.

Polikristalin Elmas (PCD) uçlar, kesme düzeninde sabitlenmiş 13,3 mm yuvarlak PCD uçlara sahip amaca yönelik tasarlanmış bir döküm matris kafaya sahiptir. Kapalı PDC matkaplar karotsuz eritme delgi operasyonları için hem maliyet hem de operasyon başarısı açısından en uygun çözümdür.

SURFACE / YÜZEY MATKAPLARI



- Pilot Surface Bits / Pilot Matkaplar
- Step Surface Bits / Basamaklı Yüzey Matkaplar

A range of surface set bits manufactured to the highest quality standards to give long service life and a maximum rate of penetration in soft to hard formations.

The range includes a variety of diamond grades, stone sizes and face profiles enabling a cost-effective solution to be chosen for most conditions.

Yumuşak ve sert formasyonlarda uzun hizmet ömrü ve maksimum penetrasyon oranı sağlamak için en yüksek kalite standartlarına göre üretilen elmas ürün grubudur. Ürün yelpazesi, çoğu koşul için uygun maliyetli bir çözüm seçilmesine olanak tanıyan çeşitli elmas kaliteleri, boyutları ve yüzey profilleri içerir.

RODS & CASINGS / TİJLER VE MUHAFAZALAR

RODS / TİJLER



Apex offers high-quality drill rods engineered for durability, precision, and reliability in demanding drilling environments. Manufactured from premium-grade steel, our drill rods provide excellent strength and wear resistance, ensuring optimal performance and longevity. Designed with precision-threaded connections, they deliver secure and efficient torque transfer while minimizing the risk of thread damage. Available BQ, NQ, HQ and PQ sizes with 1.5 m / 3.0 m options. Apex drill rods are suitable for a wide range of applications, from exploration drilling to geotechnical investigations, making them the ideal choice for your drilling operations.

Zorlu sondaj koşullarında dayanıklılık, hassasiyet ve güvenilirlik için tasarlanmış yüksek kaliteli tijlerimiz birinci sınıf çelikten imal edilmiş olup mükemmel mukavemet ve aşınma direnci sağlayarak maksimum performans ve uzun ömür sağlar. Hassas dişli bağlantılarıyla tasarlanan bu ürünler, güvenilir ve verimli tork aktarımı sağlarken dış hasarı riskini en aza indirir. BQ, NQ, HQ ve PQ boyutlarında 1,5 m / 3,0 m seçenekleriyle mevcuttur. Uygun maliyetin yanı sıra sahadaki güvenilirliği üstün performans ve uzun ömürlülüğü ile tijlerimiz fiyat-performans açısından öne çıkmaktadır.

CASINGS / MUHAFAZALAR



Apex offers premium casings specifically designed for core drilling applications. Built from high-quality materials, our casings provide essential support and stability to boreholes, ensuring smooth and efficient drilling operations.

Available in various sizes and thread configurations, they are tailored to meet the unique demands of core drilling, delivering reliable performance even in challenging formations.

Casings are engineered for durability and ease of use, making them the perfect choice for professional core drilling projects.

Yüksek kaliteli muhafaza boruları, karotlu sondaj operasyonları için özel olarak tasarlanmıştır. Sağlam yapıları sayesinde sondaj kuyularına gerekli destek ve stabiliteyi sağlayarak daha verimli ve güvenilir sondaj operasyonları sağlar. Farklı çap ve diş yapılarına sahip seçenekleriyle her türlü zorlu formasyona uygun çözümler sunmaktadır.



E - MAIL US

info@yerkuremaden.com
www.yerkuremaden.com